

**LD151** with new E1 LED Light Engine



High Power Interior/Exterior LED Uplighter

Data sheet - Page 1



Design: Greenleaf Lighting  
Project: Private Residence  
Product: LD151

The new LD151 features the all new E1 LED engine, optional glare shields and a new range of optics. Tunable White and RGBW options are also available. A powerful uplighter for its size and depth, the new LD151 has been designed specifically to produce low glare illumination to walls and columns. It can be used for a wide range of project styles with a minimal aesthetic and no visible fixings. This is a very tough, high quality fitting, machined from high grade materials ensuring excellent thermal and light output performance. Ideal for indoor or outdoor applications.

**Key Features**

- New E1 engine, featuring the CREE XHP35 LED with 2-step binning
- New optional 2nd channel LEDs for secondary lighting applications
- New 700mA option when specified with /484N concrete can, delivering up to 555 lumens
- New optics, featuring an impressively narrow 10° spot is for lighting columns and arches, or a 15°x 49° spreader lens, which is ideal for wall washing applications
- Single optic produces a very consistent beam with no multiple shadows
- LED and lens recessed in a matt black anodised body for reduced glare
- Choice of glare shields
- No visible fixings
- Range of bezel finish options
- Built-in reverse polarity protection
- LD151 is available with RGBW and Tunable White LED engines
- Available with Switch, 0-10V, DMX, Dali or Mains dimmable drivers

**Specification**

Applications						
Beam Angles	10°, 19°, 34°, 54°, 15°x 49°					
LED type	1 x E1 LED Engine with 2-step binning (LED data below)					
Colour temperature	2700K*** / 3000K / 4000K			5000K		
Current	350mA	500mA	700mA*	350mA	500mA	700mA*
LED power (Max)	5W (4.4W)**	7W (6.3W)**	10W (9W)**	5W (4.4W)**	7W (6.4W)**	10W (9W)**
CRI (Min)	85	85	85	80	80	80
Forward voltage (V) <sub>100</sub>	14V	14V	14V	14V	14V	14V
Delivered lumens (L <sub>100</sub> )****	347	437	555	374	472	599
Lumens per circuit watt	69	62	55	75	67	59
LED lifetime (to 70% lumen maintenance)	50,000hrs at a max ambient temperature of 35°C (if higher ambient then run at 500mA up to 45°C)					
Glass	6mm thick low iron glass					
Materials	Black anodised aluminium body, machine finish 316 stainless steel bezel (other options available) Sleeve - Black Acetal					
Wiring	Comes pre-wired with 250mm lead. Single colour equipped with 2 core cable, 2 Channel or TW engine with 4 core cable & RGBW with 8 core cable. Can be specified with up to 10m at extra cost.					
IP rating	IP67					

\*can only be specified with /484N concrete housing  
 \*\*indicates the nominal power for the LED run at that particular current and includes losses associated with using an 85% efficient driver  
 \*\*\*2700K lumen output is 8% lower than the 3000K figure listed  
 \*\*\*\*lumen output indicated is without the glare shield. Allow 30% less with the /GS glare shield.



**LD151** with new E1 LED Light Engine



High Power Interior/Exterior LED Uplighter

Data sheet - Page 2

**Fixing Accessories**

The fitting is supplied as standard with a fixing sleeve; this is bonded into the mounting surface first. The LD151 is secured into the sleeve by 2 'O' rings on the body. When pushed into the sleeve it creates a watertight seal.

**/484S** First Fix Sleeve supplied as standard

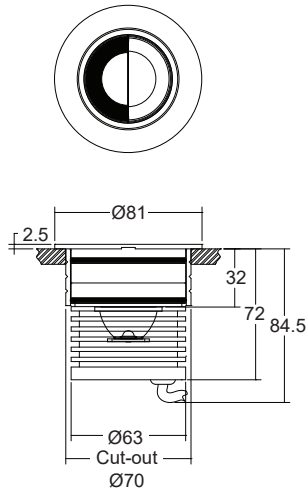

**/484N** Concrete housing

**/ID** Optional integral non-dimming driver (single colour only at 350mA or 500mA)

Concrete housing must be used when specifying the 700mA fitting. The aluminium can aids in keeping the LED fitting cool, as it helps with thermal transfer between the heat within the can to the surrounding concrete.

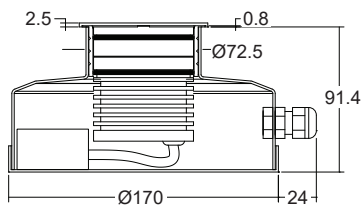

**/484GT** Ground tube

The in-ground tube has been designed for applications where a recessed uplighter is required in soil or gravel surfaces. The tube can be buried with the necessary wiring, and then the fitting installed after the landscaping work has been completed. It is supplied with the fixing sleeve bonded into the tube, and can be cut down on site.

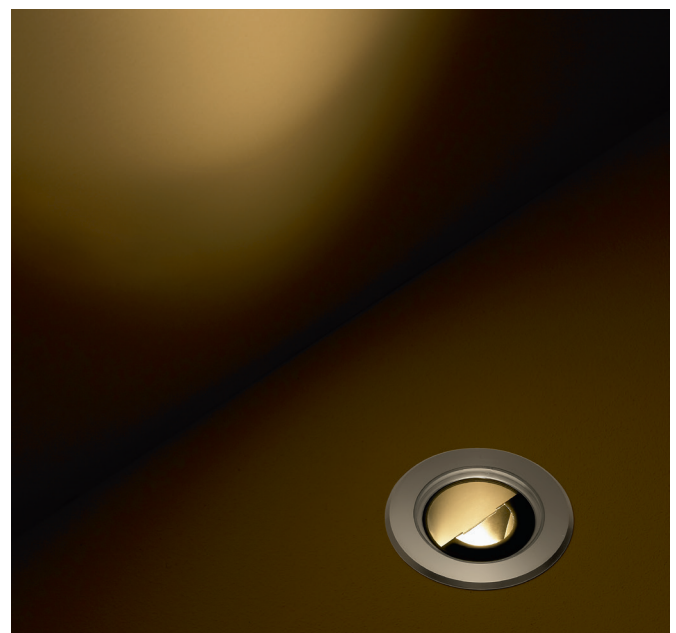
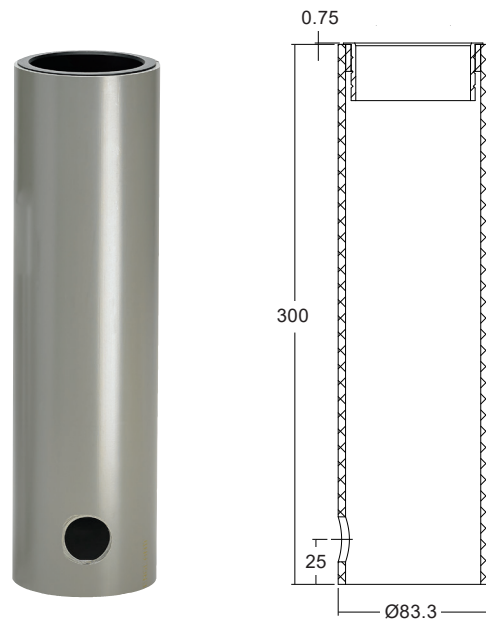

# LD151 with new E1 LED Light Engine



High Power Interior/Exterior LED Uplighter

Data sheet - Page 3

## Glare Shields

LD151 now comes with a choice of glare control options.



**/NGS**  
No glare shield. Deep recessed optic and matt black anodised optic holder aids in glare reduction.



**/GS**  
Standard glare shield introduced in 2010, which provides an excellent balance between glare control and light output. This accessory works well in most applications.



**/GSHM**  
Half-moon glare shield for applications that require very low glare. Lumen output typically reduced by 60%.

Please refer to our photometric files for lumen data. These are available to download from the website.

## Cone Diagrams

Cone diagrams below are based on a 3000K E1 LED engine run at maximum output 700mA, 10W. Images below represents beam outputs when wall washing a 3m wall, spaced 125mm away from the lit surface.

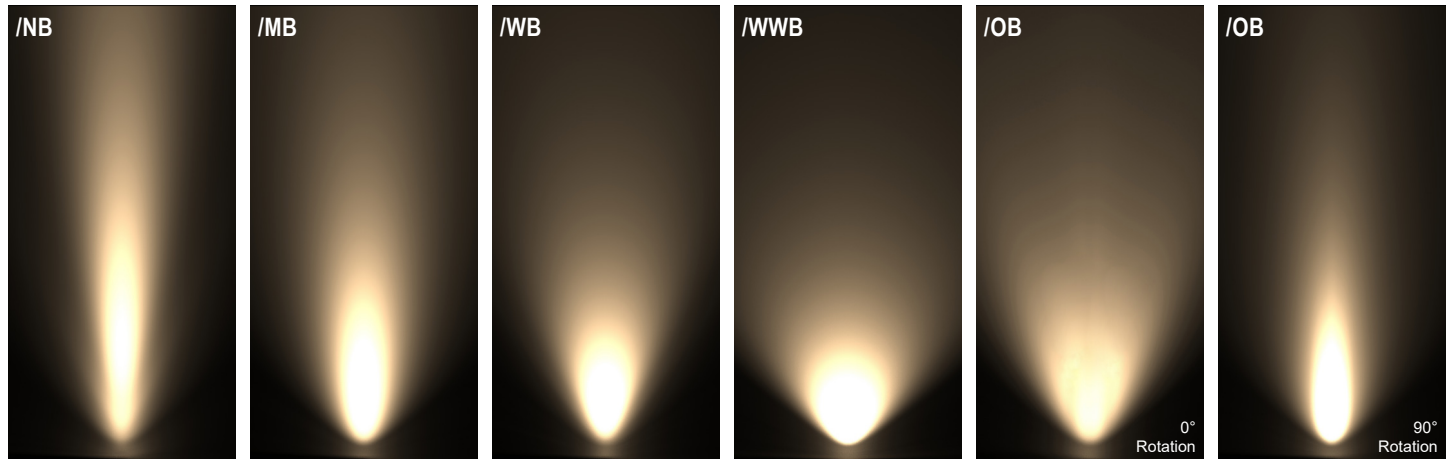

**Narrow Beam**  
700mA using a 10° optic

Distance (m)	Cone Width (m)	Luminance (lx)
3.0	0.62	750
2.5	0.52	1080
2.0	0.41	1688
1.5	0.31	3000
1.0	0.21	6751
0.5	0.10	27002

**Medium Beam**  
700mA using a 19° optic

Distance (m)	Cone Width (m)	Luminance (lx)
3.0	1.06	346
2.5	0.88	498
2.0	0.71	779
1.5	0.53	1384
1.0	0.35	3114
0.5	0.18	12456

**Wide Beam**  
700mA using a 34° optic

Distance (m)	Cone Width (m)	Luminance (lx)
3.0	1.97	114
2.5	1.64	164
2.0	1.32	256
1.5	0.99	455
1.0	0.66	1024
0.5	0.33	4095

**Extra Wide Beam**  
700mA using a 54° optic

Distance (m)	Cone Width (m)	Luminance (lx)
3.0	3.06	55
2.5	2.55	79
2.0	2.04	124
1.5	1.53	220
1.0	1.02	496
0.5	0.51	1984

**Oval Beam**  
700mA using a 15° X 49° optic

Distance (m)	Cone Width (m)	Luminance (lx)
3.0	2.70 / 0.74	190
2.5	2.25 / 0.61	274
2.0	1.80 / 0.49	428
1.5	1.35 / 0.37	761
1.0	0.90 / 0.25	1712
0.5	0.45 / 0.12	6846

Photometric files (LDT) are included in the design pack which can be downloaded from the LD151 product page on the website.

**LD151** with new E1 LED Light Engine



High Power Interior/Exterior LED Uplighter

Data sheet - Page 4

**Installation Guide**

Below is a luminaire positioning guide for white LEDs. Every project and lighting scenario will be different; the table below is to be used as a starting point for any wall wash design. Please use our photometric files to further test the desired effect for your application. Files are available on our LD151 product page on our website.

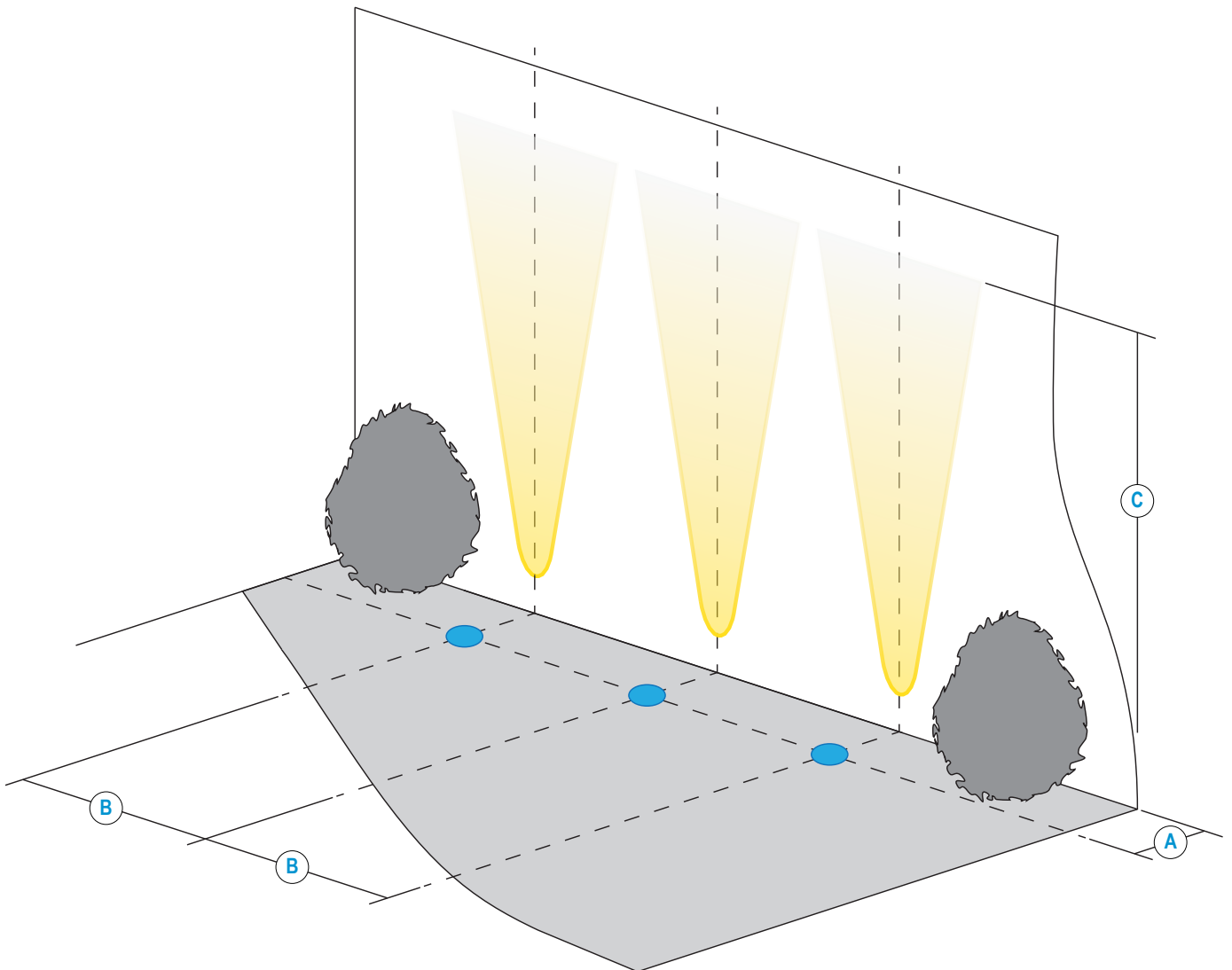

LD151-E1	/NB	/MB	/WB	/WWB	/OB
<b>A</b> Distance from the centre of the fitting to the lit surface	125mm				
<b>B</b> Spacing for an even wash	250mm*	350mm	400mm	500mm	500mm
<b>C</b> 500mA Lit distance	6m	4.5m	2m	2m	4m
<b>C</b> 700mA Lit distance	9m	5.5m	4m	3m	5m

\*Wall washing using narrow beam optics should only be used if the designer requires long distance lighting up the lit surface.



**LD151** with new E1 LED Light Engine

High Power Interior/Exterior LED Uplighter



Data sheet - Page 5

**Product Features**

**BEZEL**

High quality machined bezel available in 316 stainless steel, polished, solid & flamed bronze, paint finish white (RAL 9016) / black / RAL. Other paint finishes available, please talk to sales.

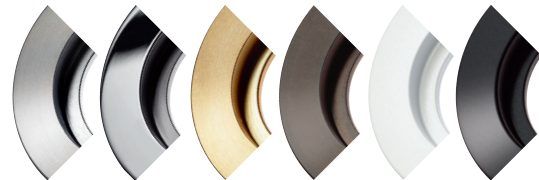

**GLASS**

6mm thick low iron glass, suitable for walkover applications.

**GLARE SHIELD**

Optional glare shield to reduce glare. With choices between our standard glare shield or a half moon glare shield design.

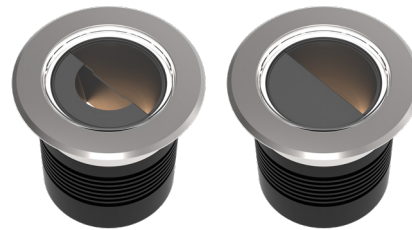

**OPTIC**

Revised high efficiency optics with a new range of beam angles to create the ideal lit effect.

**OPTIC HOLDER**

Matt black anodised for reduced glare.

**LED**

- E1 LED engine.
- E1 LED engine, with the optional 2nd channel.
- TW Tunable White LED engine.
- RGBW LED engine with colour mix lens.
- CLR Colour LED engine.

**BODY**

Machined and anodised body. 6000 series aluminium chosen for its thermal characteristics and resistance to corrosion.

**ACCESSORY**

Choose between a range of fixings options



# LD151 with new E1 LED Light Engine













High Power Interior/Exterior LED Uplighter

Data sheet - Page 6

## LED Options and Technology

### New LED Options

LD151 is now available with a choice of light engines which feature a new all copper board for increased thermal transfer. The new E1 light engine for white light applications uses the new Cree XHP35 LED and features on board polarity protection. This smaller LED chip has enabled a wider range of beam angles to be offered, coupled with increased efficiencies. This engine is also available with two extra LEDs on a second channel, for night lighting and marine navigation applications. The new tunable white engine offers a choice of dynamic colour options.

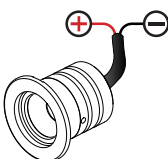
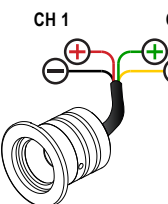
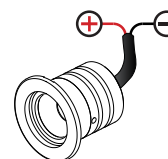
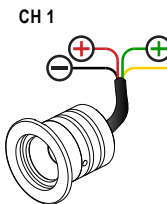
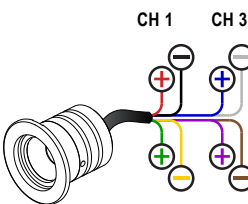
	<b>E1 Light Engine (White light)</b> 	<b>E1-2CH 2nd channel board</b> 	<b>CLR - Colour</b> 	<b>TW - Tunable White</b> 	<b>RGBW</b> 
LED Board					
LED type	Cree XHP35	Cree XHP35 + XQE's	Cree XQE's	Cree XQE's	Cree XML
Key Features	<ul style="list-style-type: none"> <li>- Available in 2700K, 3000K, 4000K and 5000K</li> <li>- Very small chip size</li> <li>- Tighter narrow beams</li> <li>- Wider range of beam angles</li> <li>- 2 step binning</li> <li>- Brighter more efficient LED</li> <li>- On board polarity protection</li> <li>- All copper LED board for increased thermal transfer</li> </ul>	<ul style="list-style-type: none"> <li>- Main white LED with optional 2nd channel for night lighting or marine navigation applications</li> <li>- 2nd channel comprises of 2 XQE LEDs mounted next to the XHP35</li> <li>- Beam shape from the XQE's is different from the main LED as they are mounted to the sides of the optic</li> <li>- 2 driver circuits required</li> <li>- All copper LED board</li> </ul>	<ul style="list-style-type: none"> <li>- 4 colour XQE LEDs mounted under a single optic</li> <li>- All copper LED board</li> <li>- Red, Blue, Green and Amber colour LED options</li> <li>- Single LED circuit</li> </ul>	<ul style="list-style-type: none"> <li>- 4 XQE LEDs mounted under a single optic</li> <li>- 2 LEDs per colour</li> <li>- Excellent dynamic white mixing from a range of optics</li> <li>- All copper LED board</li> <li>- 2 driver circuits required</li> </ul>	<ul style="list-style-type: none"> <li>- RGBW LEDs mounted under a single 26deg optic for superb colour mixing</li> <li>- White LED is 4000K</li> <li>- All copper LED board</li> <li>- 4 LED circuits required</li> </ul>
Cables					
Lumen output	See front page	See front page		See table below	

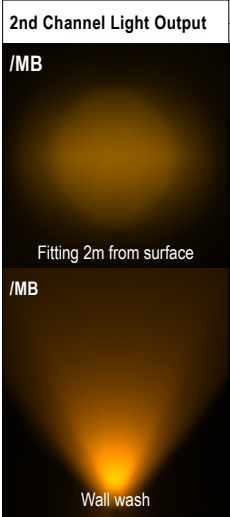

Colour temperature	Warm White 2700K or 3000K	Cool White 4000K or 5000K
Current	500mA	500mA
LED power (Max) All channels in use	7W (6.3W) 3.5W per channel	
CRI (Min)	85	
Delivered lumens (L <sub>100</sub> )	148lm	188lm
Lumens per circuit watt	42	54

### Industry Leading LED Thermal Management

High quality, embedded copper PCB, with direct contact cooling for the LEDs providing industry leading thermal management of the LED. Guaranteeing long life and minimal colour shift.



**LD151** with new E1 LED Light Engine

High Power Interior/Exterior LED Uplighter

Data sheet - Page 7

**Order Codes and Options****White LED Options - E1 Light Engine**

Product code	LED colour	Beam angle	Glare shield	Finish	Fixing
LD151-E1 - 350 - 500 - 700					

Example: LD151-E1-700 / LW30 / NB / NGS / Stainless Steel / 484N

**Product codes with output options**

5W LED at 350mA	LD151-E1-350
7W LED at 500mA	LD151-E1-500
10W LED at 700mA (Must be specified with /484N)	LD151-E1-700

**LED colour options**

LED colour options	Suffix
Extra Warm White (2700K)	/LW27
Warm White (3000K)	/LW30
White (4000K) - on request	/LW40
Cool White (5000K)	/LW50
With 2nd channel (red for navigation or amber night lighting) LD151-E1-2CH	/LW**+L*

\*Other LED colour temperatures are available. Please speak to a member of our sales team.

**Beam / lens angle options**

10° narrow spot	/NB
19° medium	/MB
34° wide	/WB
54° extra wide	/WWB
15° x 49° oval	/OB

**Glare shield**

No glare shield	/NGS
Standard glare shield	/GS
Half-moon glare shield	/GSHM

**Bezel finish options**

Stainless steel 316
Paint finish white / black / RAL (not suitable for high traffic areas)
Polished and passivated stainless steel (for marine environments)
Flamed solid bronze (antique finish)

**Fixing accessories**

First fix sleeve (supplied as standard)	/484S
Concrete housing (specify when choosing LD151-E1-700)	/484N
with integral non-dimming driver (350mA & 500mA outputs only)	/ID
Ground tube	/484GT

**Use with 350mA, 500mA & 700mA constant current LED drivers**

We have a wide range of dimmable LED drivers, 0-10V, DMX, DALI and Mains dimmable. Please see the downloads section on our website:  
 To run 1-4 LD151-E1-350 in series use a TXDEL350D (0-10V dimmable)  
 To run 1-4 LD151-E1-500 in series use a TXDEL500D (0-10V dimmable)  
 To run 1-3 LD151-E1-700 in series use a TXDEL700D (0-10V dimmable)

**Colour LED Options - CLR Light Engine**

Example: LD151-CLR-500 / LR / MB / NGS / Stainless Steel / 484N

**LED colour options (max 500mA)**

LED colour options (max 500mA)	Suffix
Red	/LR
Green	/LB
Blue	/LG
Amber	/LA

Driver requirements identical to E1 engine, beam angles identical to TW engine

**Tunable White Options - TW Light Engine**

Product code	LED colour	Beam angle	Glare shield	Finish	Fixing
LD151-TW - 350 - 500					

Example: LD151-TW-500 / LW27 + LW40 / NB / NGS / Stainless Steel / 484N

**Product codes with output options**

5W LED at 350mA - 2 channels of 2 x 1.2W	LD151-TW-350
7W LED at 500mA - 2 channels of 2 x 1.7W	LD151-TW-500

**LED colour options**

LED colour options	Suffix
Tunable White 2700K & 4000K (standard option)	/LW27 + LW40
Tunable White 2700K & 5000K	/LW27 + LW50
Custom	/LW** + LW**

Fitting comprised of 2x LEDs in one colour temperature & 2x LEDs in another. Other white colour options available on request, please discuss with our sales team.

**Beam / lens angle options**

Narrow spot not available due to poor colour mixing	
24° medium	/MB
38° wide	/WB
54° extra wide	/WWB
20° x 46° oval	/OB

**Beam, Bezel and Glare shield options**

Same as White LED options using the E1 Light Engine

**Finish and fixing options**

Same as White LED options using the E1 Light Engine

**Use with 350mA & 500mA constant current LED drivers**

We have a wide range of dimmable LED drivers, 0-10V, DMX, DALI and Mains dimmable. Please see the downloads section on our website:  
 To run 1-7 LD151-TW-350 in series use 2x TXDEL350D (0-10V dimmable)  
 To run 1-7 LD151-TW-500 in series use 2x TXDEL500D (0-10V dimmable)

**Colour Change RGBW Options - RGBW Light Engine**

Product code	Glare shield	Finish	Accessories
LD151-RGBW - 350 - 500			

Example: LD151-RGBW-500 / Stainless Steel / NGS / 484N

**Product codes with output options**

5W LED at 350mA (4x 1.2W LEDs)	LD151-RGBW-350
7W LED at 500mA (4x 1.7W LEDs)	LD151-RGBW-500

RGBW features a 4000K white LED for creating hues

**Beam / lens angle options**

38° colour mix lens

**Bezel and Glare shield options**

Same as White LED options using the E1 Light Engine

**Finish and fixing options**

Same as White LED options using the E1 Light Engine

**Use with 350mA & 500mA constant current LED drivers**

We have a range of dimmable LED drivers DMX and DALI compatible. Please see the downloads section on our website:  
 To run 2-13 LD151-RGBW-350 in series use a TXDEL4A350DMX or TXDEL4A350DALI  
 To run 2-13 LD151-RGBW-500 in series use a TXDEL4A500DMX or TXDEL4A500DALI